

Product Information



FTF230x82-Ø45-5xØ14

EAN 4031582331974

Drive wheel, wheel center made of cast iron, painted, tread made Polyurethane, casted

Technical Data

Wheel diameter	230 mm
Tread width	82 mm
Axle Hole-Ø	45 mm
Temperature	- 20 / + 60 °C
Weight	5.846 kg
Hardness of tread	A 92 Shore
Hole-Ø	70 mm
Fitting-Hole-Ø	14 mm

Roll performance	+	+	+	+	+
Movement noise	+	+	+	+	+
Attrition	+	+	+	+	+
Corrosion resistance	+	+	+	+	+

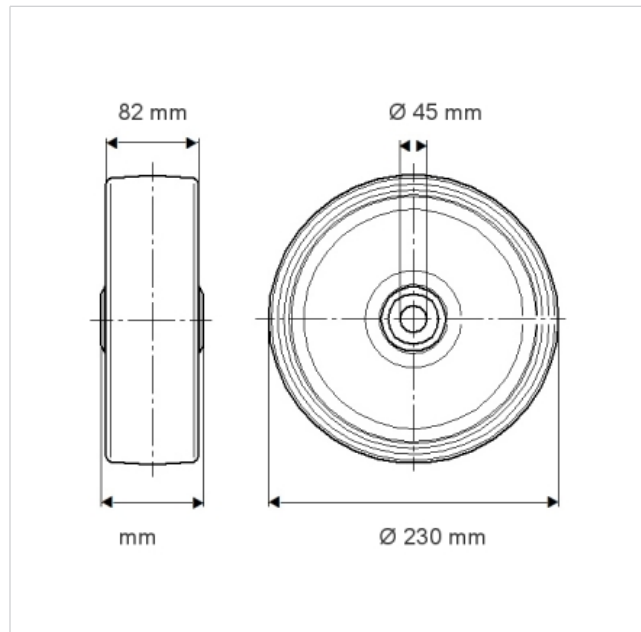

Product Information



FTF230x82-Ø45-5xØ14

EAN 4031582331974

